

# Steerable Microwave Antenna Systems

(with 0.9 m, 1.2 m or 1.8 m Reflector)

## AC090•AC120•AC180

1 GHz to 18 GHz (optionally up to 40 GHz)

## Technical Information

Subject to change, 2006-04-25, 8GEP Fr/Ni/Fi



# SHF Directional Antenna Systems AC090/AC120/AC180

## Technical Information

### **General**

The Microwave Antenna Systems AC090, AC120 and AC180 are used for detecting and monitoring terrestrial and satellite signals in the microwave range from 1 GHz to 18 GHz (optional 1 GHz to 40 GHz). The antennas are intended for outdoor installation. They are positioned in azimuth ( $\pm 180^\circ$ ) and elevation ( $-5^\circ$  to  $+95^\circ$ ) from a detached control unit, which is provided with a computer interface for use in complex, remotely controllable radiomonitoring systems. Rotation about the two axes, azimuth and elevation, can be made simultaneously. The following modes are possible:

### Manual:

Clockwise or counter clockwise rotation and tilting up or down

- By cursor controlling
- By numerical input of azimuth and elevation

### Automatic:

- Auto-orientation to preset azimuth and elevation values
- Sector scanning (optionally)
- Raster scanning (optionally)

The active feed is fitted near the focus of the reflector. It consists of a linear or dual linear polarized Log-periodic Antenna followed by an LNA unit. This combination minimizes losses occurring between antenna and receiver. The gain of the preamplifiers ensures that an optimum compromise between system noise figure and dynamic range is obtained despite the cable losses.

In case of an optional frequency extension to 40 GHz, the polarization as well as the antenna are chosen via a RS232/RS485 control board connection. A WIN 95/98 or WIN-NT 4.0 operation MMI is included.

# SHF Directional Antenna Systems AC090/AC120/AC180

## Technical Information

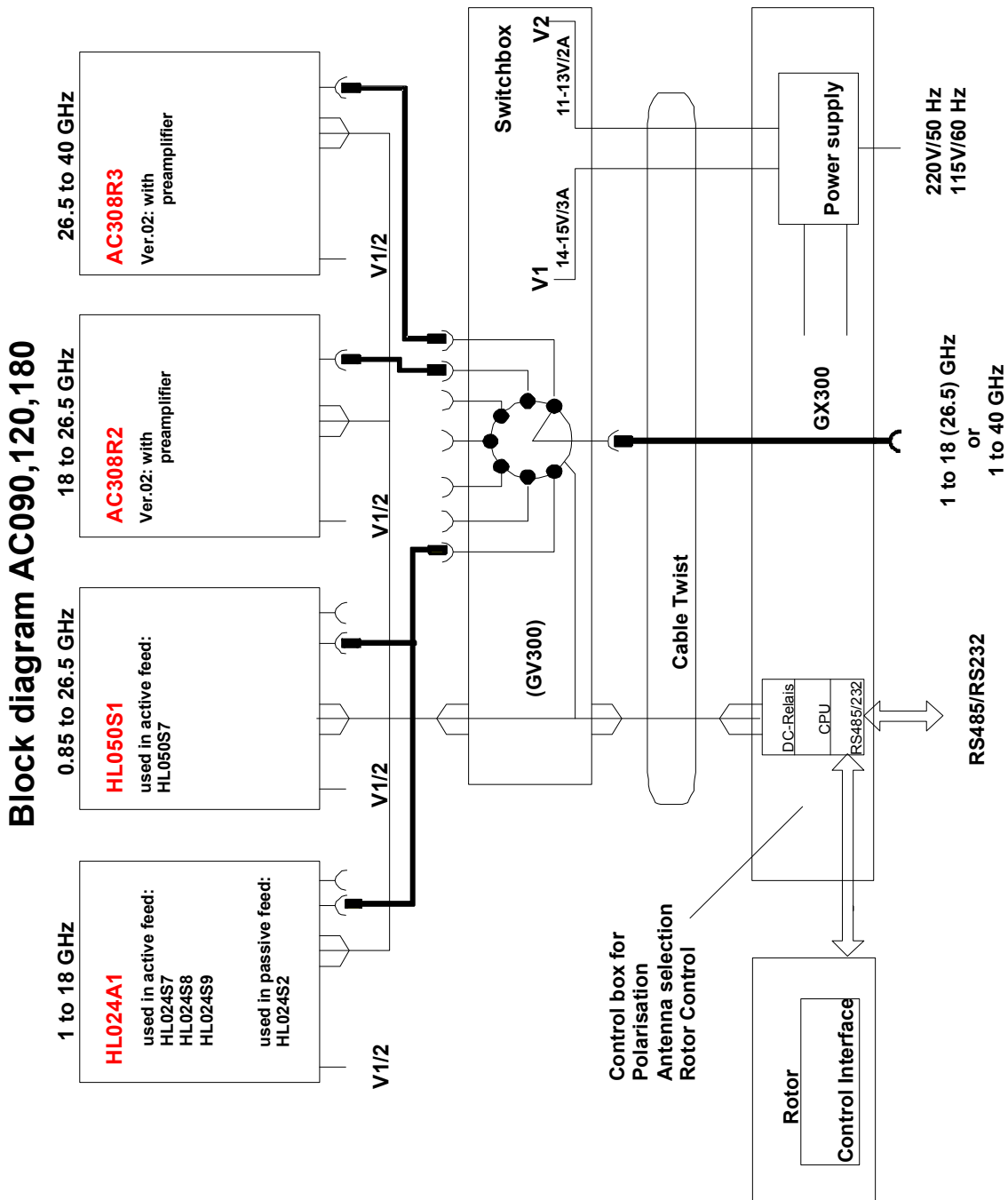

# SHF Directional Antenna Systems AC090/AC120/AC180

## Technical Information

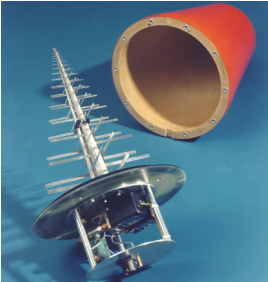
Active feeds	Polarization
<b>HL050S7:</b> Includes preamplifier and bypass, one output	linear; (depending on feed position: horizontal or vertical)
<b>HL024S7:</b>  includes preamplifier, polarization switch, bypass and test input; one output	horizontal or vertical, (remote controlled)
<b>HL024S8:</b> includes preamplifier, polarization switch, bypass; two outputs	horizontal and vertical, (remote controlled)
<b>HL024S9:</b> includes preamplifier and polarization switch, one output	circular left or circular right or horizontal or vertical, (remote controlled)

# SHF Directional Antenna Systems AC090/AC120/AC180

## Technical Information

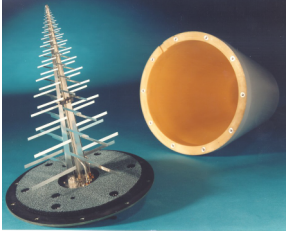
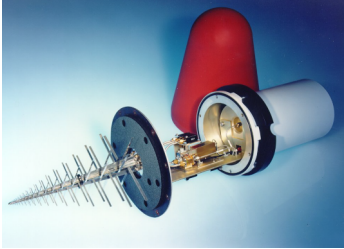
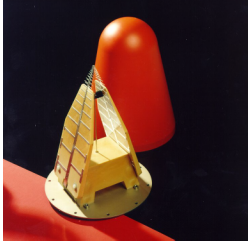
Passive feeds	Polarization
<p><b>HL024S1:</b></p> <p>two separate outputs</p>  The image shows the HL024S1 antenna system, which consists of a cylindrical horn antenna with a metal mesh surface and a central feed structure. A separate orange-colored component, likely a feed or connector, is shown next to it.	<p>Linear (horizontal and vertical)</p>
<p><b>HL024S2:</b></p> <p>includes polarization switch, one output</p>  The image shows the HL024S2 antenna system, which features a red horn antenna with a white cylindrical component at the base. A metal mesh antenna is visible inside the white component.	<p>horizontal or vertical or circular left or right, (remote controlled)</p>
<p><b>HL050S1:</b></p> <p>one output</p>  The image shows the HL050S1 antenna system, which is a yellow horn antenna with a red cylindrical component at the base.	<p>Linear, (depending on feed position: horizontal or vertical)</p>

# SHF Directional Antenna Systems AC090/AC120/AC180

## Technical Information

### System Data

The amplifiers and cables used in the AC090/AC120/AC180 have been selected for their RF characteristics to be suitable for a typically connected microwave receiving system. To allow determination of system characteristics such as dynamic range and sensitivity, the data of the used active feed i.e. typical attenuation and gain have to be taken into account. For this purpose please refer to the following tables.

<b>HL024S7, HL024S8 and HL050S7</b>			
Feed output (passive)		see gain diagram page 10	
Amplifier:	Gain:	27 dB (typ.)	
	Gain flatness:	± 2 dB (typ.)	
	Noise figure:	< 3.6 dB (typ.)	
	Output power: (1dB - compression point)	> 5 dBm (typ.)	
Cable and switching loss:		3 dB at 1 GHz (approx.)	10 dB at 18 GHz (approx.)

<b>HL024S9</b>			
Feed output (passive)		see gain diagram page 10	
Amplifier:	Gain:	27 dB (typ.)	
	Gain flatness:	± 2 dB (typ.)	
	Noise figure:	< 3.6 dB (typ.)	
	Output power: (1dB - compression point)	> 5 dBm (typ.)	
		<b>at 1 GHz</b>	<b>at 18 GHz</b>
Cable and switching loss: (approx.)		3 dB (linear)	10 dB (linear)
		6 dB (circular)	14 dB (circular)

# SHF Directional Antenna Systems AC090/AC120/AC180

## Technical Information

### **Frequency Extension**

The frequency range of the SHF Directional Antenna System AC300 can optionally be extended up to 40 GHz. Please see separate brief Technical Information for AC308R2/R3.

The range 18 GHz to 40 GHz is covered by two smaller reflector antennas which will be laterally flanged to the reinforced outer rim of the 3-m reflector and point to the same direction. They are optimally suited for the subranges 18 GHz to 26.5 GHz (K band) and 26.5 GHz to 40 GHz (Ka band). They are fitted with extremely low-noise amplifiers that ensure high system sensitivity in these two bands as well. The polarization of the two additional antennas is linear but can be set manually to either horizontal or vertical polarization or even to a polarization of 45° which halves the time required for searching of unknown signals.

The signals are amplified in the antenna output and selected via the antenna selector.

# SHF Directional Antenna Systems AC090/AC120/AC180

## Technical Information

### Technical Data

Antenna System	AC090	AC120	AC180
Frequency range		1 GHz to 18 GHz	
Polarization		depending on feed	
Gain	15 dBi to 40 dBi	19 dBi to 42 dBi	23 dBi to 45 dBi
Half power beamwidth	approx. 19° to 1.1°	approx. 17° to 0.9°	approx. 12° to 0.7°
Dish diameter	0.9 m	1.2 m	1.8 m
Surface accuracy (RMS value)		< 0.43 mm	
Permissible wind speed (with 1 cm ice deposit)		160 km/h	
Permissible wind speed (operation)		120 km/h	
Rated temperature range		-30°C to +55°C	
Dimensions		see figure	
Overall weight	approx. 165 kg	approx. 170 kg	approx. 420 kg

Optional extension up to 40 GHz 0.25 m Reflector Antenna System	AC308R2	AC308R3
	Frequency	18 GHz to 26.5 GHz
Polarization	H/V/45° slant	H/V/45° slant
Gain	29 dBi to 33 dBi	33 dBi to 36 dBi
Half power beamwidth	4.5° to 3°	3° to 2°
Dish diameter	0.25 cm	0.25 cm
Permissible wind speed (with 1 cm ice deposit)	160 km/h	160 km/h
Rated temperature range	-30°C to +55°C	-30°C to +55°C



# SHF Directional Antenna Systems AC090/AC120/AC180

## Technical Information

<b>Antenna Rotor</b>	
Range of rotation	azimuth: 0° to 360° elevation: -5° to +95°
Speed of rotation	azimuth: $\geq 5^\circ/\text{s}$ elevation: $> 1.5^\circ/\text{s}$ , typ. $2^\circ/\text{s}$
Accuracy (azimuth/elevation)	$\pm 0.2^\circ$
Operating voltage	24 V <sub>DC</sub>
Maximum inrush current	AC090/AC120: max. 6 A AC180/AC120: max. 8 A
Operating current	AC090/AC120: azimuth: max. 1.5 A elevation: max. 1.5 A AC180: azimuth: max. 4 A elevation: max. 3.5 A
Weight (incl. transport frame, counterweight and tube mast)	AC090 / AC120: approx. 130 kg AC180: approx. 280 kg

### Control Unit GX300

The antenna control unit serves to control the antenna rotor and the used feeds. It can be operated by a host PC (not included) at a location of up to 1000 m away (RS485), closer distances up to 20 m even by RS232.

The host PC must be equipped with an RS232 respectively RS485 interface card. A Windows based MMI is part of the delivery.

Please refer to the separate Technical Information for GX300.

# SHF Directional Antenna Systems AC090/AC120/AC180

## Technical Information

### Antenna gain (typical)

with feeds HL024xx or HL050xx

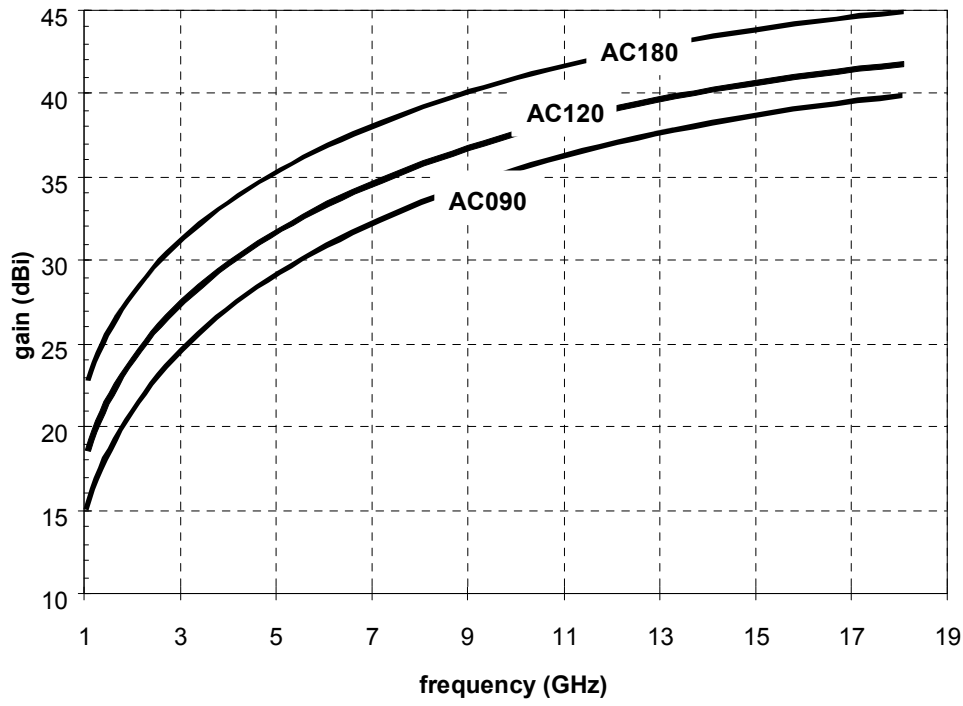

### Antenna half power beamwidth (typical)

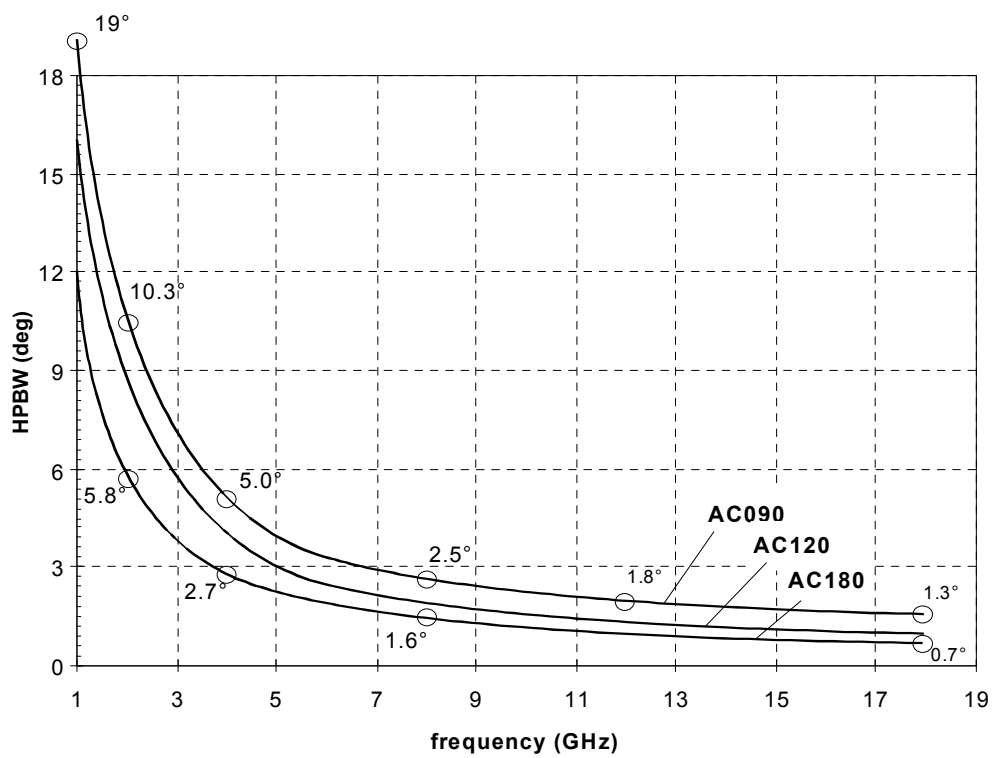

# SHF Directional Antenna Systems AC090/AC120/AC180

## Technical Information

### Steerable Microwave Antenna System AC090, AC120 and AC180

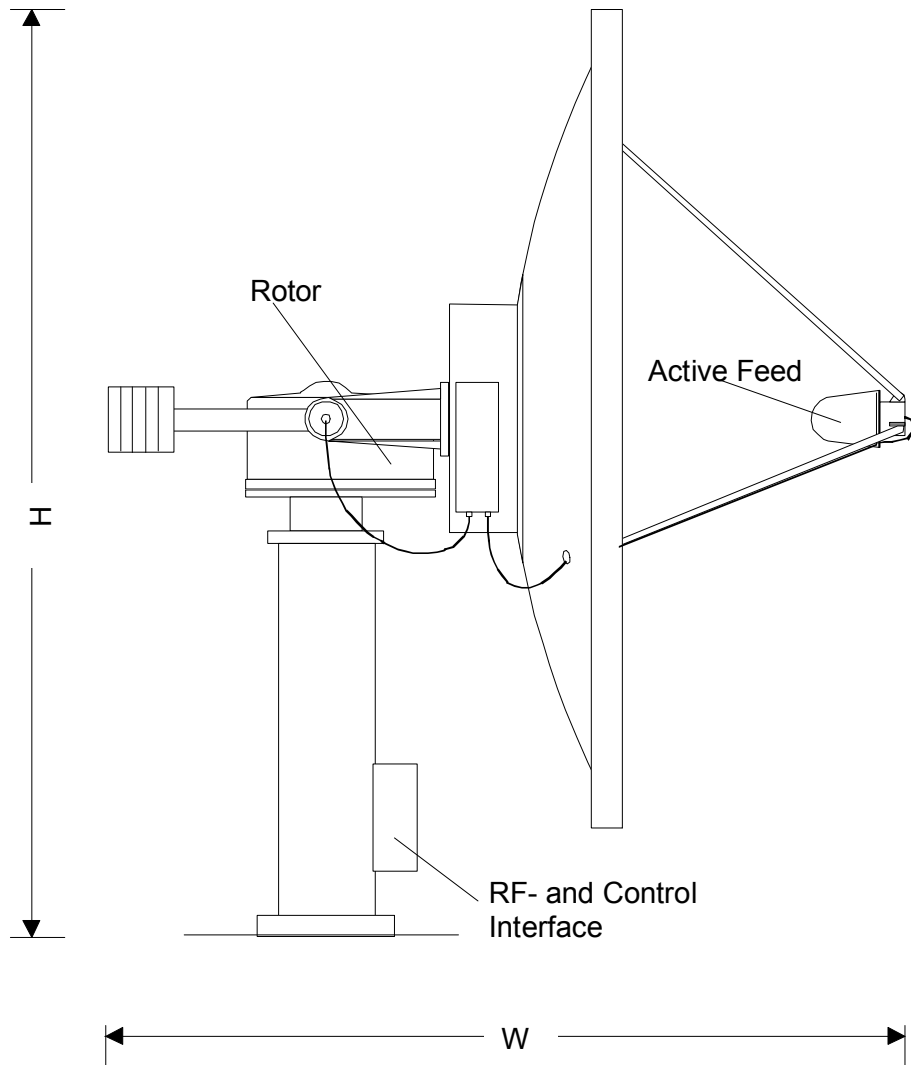

Dimensions (approx.):	H	W
AC090	2.5 m	1.6 m
AC120	2.7 m	1.8 m
AC180	3.2 m	2.3 m